



# EZ-RO SYSTEMS

## INSTALLATION & OPERATION GUIDE

For Reverse Osmosis Systems  
with Atmospheric Tanks

## SAFETY INSTRUCTIONS

---

### NOTES

- The appliance is only to be installed in locations where its use and maintenance are restricted to trained personnel.
- Children should be supervised to ensure that they do not play with the appliance.
- Cleaning and user maintenance shall not be made by children without supervision.
- The appliance is not suitable for installation in an area where a water jet could be used.
- If the supply cord is damaged, it must be replaced by the manufacturer, its service agent or similarly qualified persons in order to avoid a hazard.
- Substances listed as reduced are not necessarily in your water. System must be maintained according to manufacturer's instructions, including replacement of filter cartridges.
- Your water must be within required influent water characteristic limits for satisfactory operation. If not, the reverse osmosis (RO) membrane cartridge's life may be shortened and your warranty will be voided (see Installation Requirements).
- Install on cold water line only. Tempered water up to 80°F (26.7°C) can be used.
- Do not install where system will be exposed to direct sunlight.
- Make certain that installation complies with all state and local laws and regulations. Only use PTFE thread seal tape or plumbers tape without adhesive backing to seal joints. Do not use pipe compound ("pipe dope"), sticks, or similar compounds with this unit; they contain petroleum derivatives which can cause crazing and cracking of the plastic in the filter housing.
- Improper connection of the appliance-grounding conductor can result in a risk of electric shock. Check with a qualified electrician or service representative if you are in doubt whether the appliance is properly grounded. Do not modify the plug provided with the appliance; if it will not fit in the outlet, have a proper outlet installed by a qualified technician.
- The appliance is intended to be permanently connected to the water mains and not connected by a hose-set.
- Before installing the system, make certain your water supply complies with the following operating specifications. Failure to do so may reduce the effectiveness of the system and will void the warranty. Consult your local water treatment utility or a certified water testing lab to determine the quality of your water.
- Do not use with water that is microbiologically unsafe or of unknown quality without adequate disinfection before or after the system. The Pentair EZ-RO System will not protect against disease-causing bacteria or remove naturally occurring harmless bacteria.
- The EZ-RO System contains replaceable components that are critical to the efficiency of the system. Replacement of the reverse osmosis component should be with one of identical specifications, as defined by the manufacturer, to assure the same efficiency and contaminant reduction performance.
- The EZ-RO System has filter cartridges and an RO membrane cartridge included with the system that have limited service lives which are critical for the effective reduction of total dissolved solids. Product water should be tested periodically to verify that the system is working properly.
- The power supply must be securely mounted in a dry location, unlikely to get wet due to potential leaks or splashes from the RO processor or the tank assembly.

### WARNINGS

- Installation shall comply with applicable local, state, and national plumbing and electrical regulations.
- This appliance must be grounded. This appliance is equipped with a cord having an appliance-grounding conductor and a grounding plug. The plug must be plugged into an appropriate outlet that is installed and grounded in accordance with all local codes and ordinances. If the supply cord is damaged, it must be replaced by the manufacturer, its service agent or similarly qualified persons in order to avoid a hazard.

### CAUTIONS

- The EZ-RO System must be protected against freezing which can cause the filter housing to crack, resulting in water leakage.
- Do not use electrical heating tape or a propane torch on this unit.

# EZ-RO REVERSE OSMOSIS SYSTEM

## INSTALLATION AND OPERATION GUIDE FOR MODEL NUMBERS:

EZ-RO 375/16ATM

EZ-RO 375/30ATM

EZ-RO 375/50ATM

EZ-RO 650/16ATM

EZ-RO 650/30ATM

EZ-RO 650/50ATM

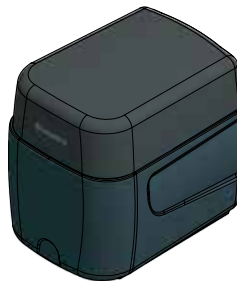
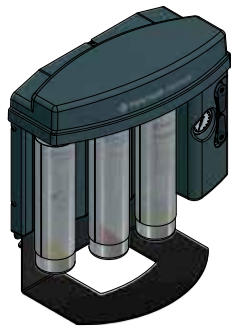

Wall-mounted EZ-RO processor

EZ-RO on (optional) floor stand

Atmospheric tank sizes, depending on model purchased: 16 gal, 30 gal, 50 gal

## INDEX

Safety Instructions.....	2	Reject Flow Restrictor Chart .....	13
Introduction .....	3	Twenty-four Hour Membrane Flush .....	14
General Information .....	4	ATM Tank Fill and Pump Startup .....	15
Unpacking and Inspection .....	4	Flush Buffer Tank.....	16
Part Names .....	5	Connect to Equipment .....	17
Installation Requirements.....	6	Filter Change and Flushing Procedure.....	18
Items Required for Installation .....	7	Troubleshooting.....	21
Using Push-to-Connect Fittings.....	7	ATM Water Storage Cleaning Guide .....	24
Wall-Mount Installation .....	8	Replacement Parts .....	25
Optional Floor Stand Mount Installation.....	8	Dimensions .....	26
Connect Tubing.....	9	Plumbing Flow .....	27
Attach Solenoid Cable and Power Cords.....	11	NSF Product Certification Information.....	28
System Startup and Flushing Process.....	12	Warranty Information .....	28

## INTRODUCTION

Leveraging proprietary technology, the Pentair® Everpure® EZ-RO system provides high quality water for applications, such as steam. The system combines multiple water treatment technologies, that meets combi oven and steamer equipment and customer water quality standards, known to significantly reduce scale and corrosion problems due to high TDS, water hardness†, and chlorides\* while reducing dirt†, particulates† and dissolved solids that may foul or scale equipment or may contribute to corrosion.

\*When installed, serviced and maintained according to Pentair Everpure installation and operation instructions.

† These contaminants are not performance tested or certified by NSF®.



## GENERAL INFORMATION

### EZ-RO for Hardness Minerals and Undesirable TDS

Unfiltered water can degrade equipment and affect product taste, which hits food service business owners two ways—operational costs and profit loss. Like most reverse osmosis systems, EZ-RO reduces contaminants before they enter the equipment and the end user experience.

EZ-RO reduces high TDS (Total Dissolved Solids) on a molecular level. The CM mineral addition cartridge provides TDS needed for conductivity sensors and optimal mineral content for steam equipment. It achieves next level quality water through its ease of use from install through on-going maintenance, water efficiency, and expandability.

### Quality System for Quality Water

EZ-RO features a compact body with a built-in bypass and flush valves, so you cut down on steps during install and servicing. From there, we ensure seamless performance. The reimagined RO solution filters contaminants—all while adding back the minerals you want. This tailored blending process moderates the right amount of dissolved minerals to achieve your desired final water quality.

**Easy** – With more accessible parts and no extra SKUs, this all-inclusive system makes specification, installation, and maintenance easier. It's universal, so contractors know what they're dealing with after one encounter.

**Expandable** – Our system grows with the business by design. The system is compact, yet customizable to expand no matter how it's installed—wall mounted, free standing or under the counter. Upgrade filters or tanks as operational needs increase, as available.

**Efficient** – The small footprint optimizes space. The remineralization technology safeguards the investment to avoid premature replacements as the high output membrane recovers up to 50% water.

## UNPACKING AND INSPECTION

Inspect the carton for damage. Carefully unpack and inspect each item. Report any damage to freight carrier immediately and retain all packaging materials.

The Pentair EZ-RO system includes all the necessary fittings for installation except for an air gap for the waste water. Lengths of 1/4", 3/8" and 1/2" tubing have been provided.

The Pentair EZ-RO system is packaged as a complete unit in two cartons. You should have the following:

	Parts	Quantity
<b>Box 1</b>	1. EZ-RO Processor with Plug	1
	2. Pre Filter Cartridge	1
	3. CM Mineral Addition Cartridge size 4 or 7	1
	4. EZ-RO Membrane: Size 375 or 650	1
	5. Installation Kit, Tubing	1
	6. Installation and Operation Guide (not shown)	1
<b>Box 2</b>	A. Atmospheric Tank Assembly: 16, 30, or 50 Gal	1
<b>Box 3</b>	Optional Floor Stand (if ordered) (See page 25.)	1

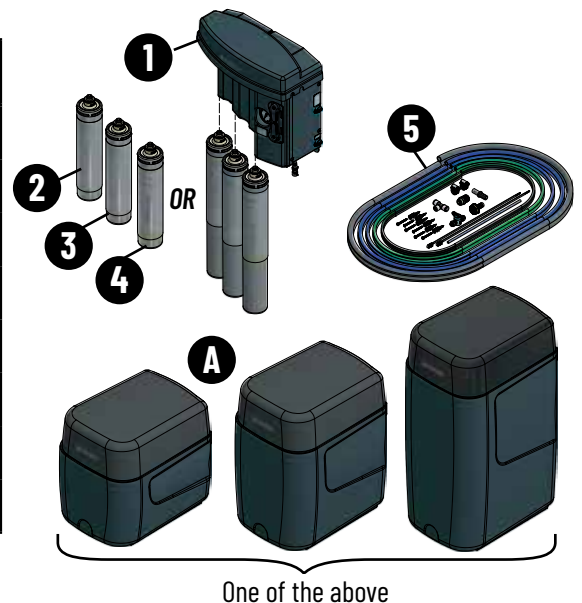

Before mounting the EZ-RO System, inspect the parts. Use the table and illustration provided to verify the parts and quantities. If you do not have these components, do not attempt to install this system. Contact Everpure for assistance. If any parts are missing, contact customer service at 800.942.1153 / 630.307.3000 or by email at [cseverpure@pentair.com](mailto:cseverpure@pentair.com).

# PART NAMES

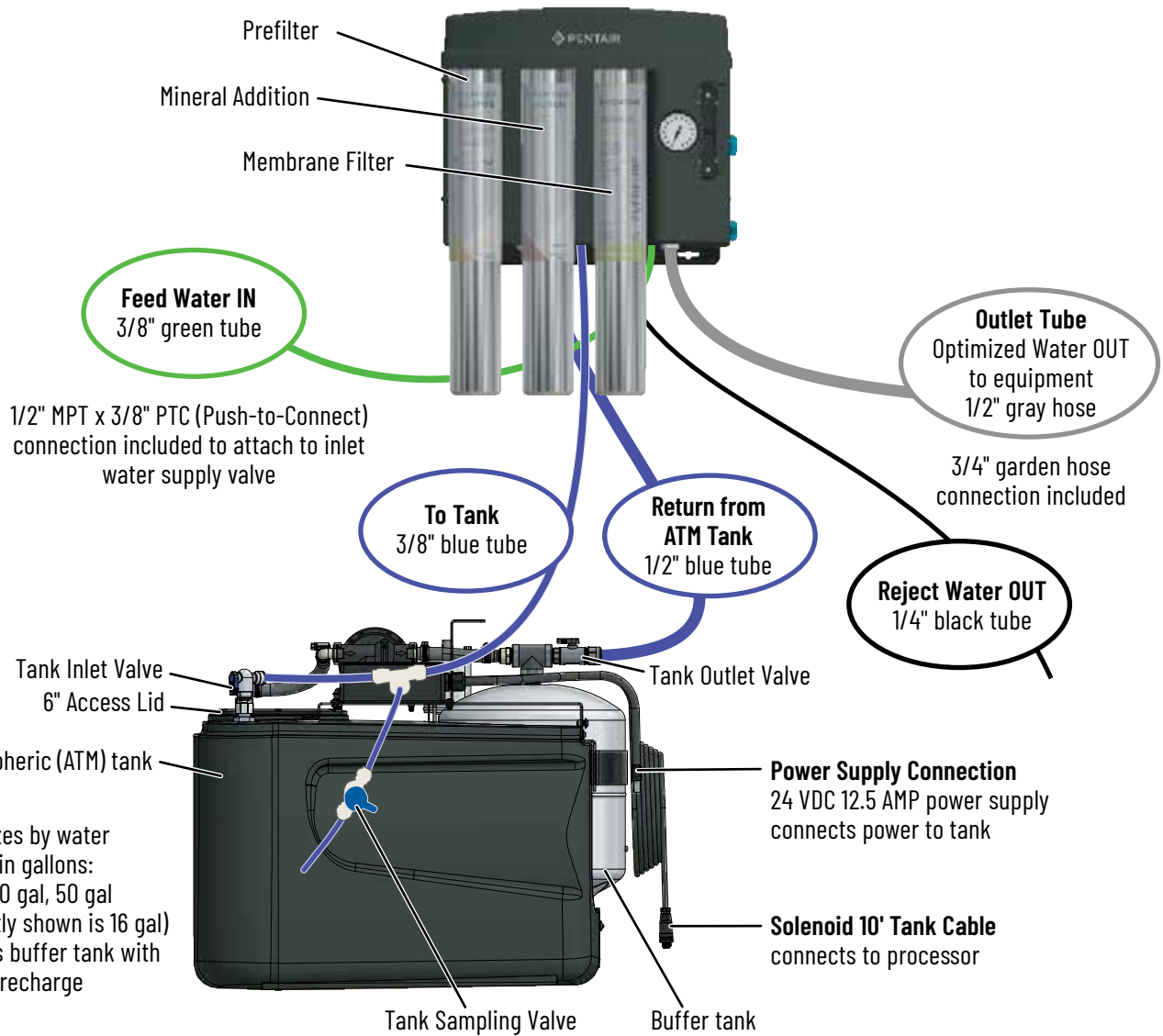
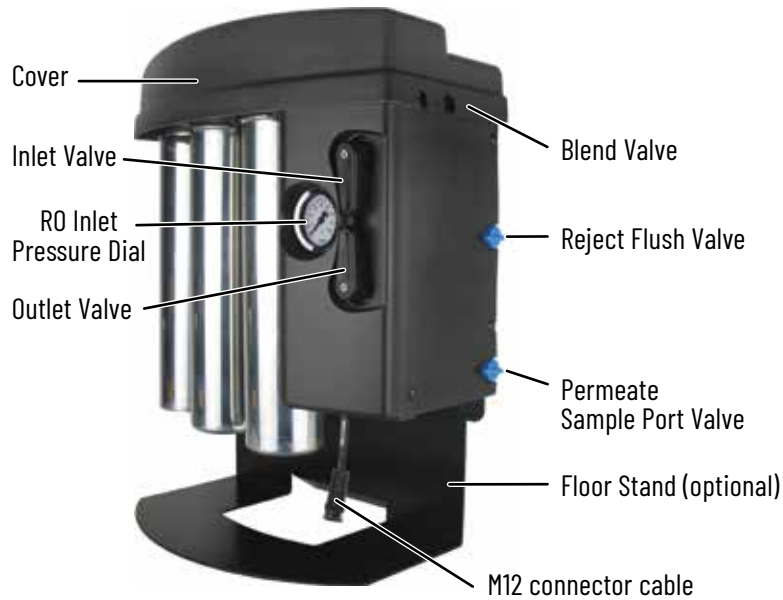

## INSTALLATION REQUIREMENTS

This product is for commercial use only and must be installed and maintained in accordance with manufacturer's guidelines and local regulatory plumbing and electrical codes.

### LOCATION

The system should be installed indoors and close to:

- Electrical outlet (120vac, 60hz) with space for one plug (within five feet of tank)
- RO processor: The atmospheric tank can be no further than 10 feet from the RO processor due to the tubing connections and solenoid cable.
- Water source
- Drain (within five feet of unit)
- Equipment served

Do not let the processor or storage tank freeze or be exposed to rain or direct sunlight.

### WATER REQUIREMENTS

#### Feed Water

Adequate flow and pressure of water to the unit is essential.

Water supply should be:

- Cold water only. Tempered water up to 80°F (26.7°C) can be used.
- Minimum 50 psi dynamic pressure, maximum 100 psi static pressure.
- Supplied by a dedicated 1/2" water line to the installation.

Install a full-flow ball valve and pressure gauge with 1/2" female pipe thread (user supplied) for connection to installation hardware provided with the system.

#### Feed-water Chemistry

Operating a system on water supplies outside of these parameters may lead to premature membrane failure.

Feed TDS	Up to 1000 ppm
Feed pH	5 - 10
Hardness	<12 grains
Free chlorine	<3.0 mg/l
Turbidity	<1.0 NTU
Iron (Fe)	<0.1 mg/l
Manganese	<0.05 mg/l
Hydrogen sulfide	0.0 mg/l
Silica	<20 mg/l

**A water analysis** must be conducted before installing the system, or the required information can be obtained from your local water utility. If your water analysis shows that any of these parameters are not within range, additional pretreatment and/or higher frequency of maintenance may be necessary. Contact your Everpure distributor for assistance.

#### The membrane can be fouled by:

- Silica
- Flocculants such as alum or cationic polymers
- Hardness, iron, manganese and hydrogen sulfide

The presence of silica or flocculants in the feed water may require special chemical pretreatment or more frequent membrane replacing. **Please note that membrane failure due to fouling is not covered by the warranty.**

### DRAIN

The drain should:

- Be located within five feet of the unit
- Have a locally compliant air gap

The drain must:

- Allow a minimum flow of two gallons per minute
- Be accessible for system set-up and service

### STORAGE TANK

The tank must be located **10 feet or less** from the water processor unit. The floor beneath the storage tank should be smooth, clean and free of sharp objects that could scratch or puncture the bottom of the tank.

### OPTIMIZED WATER LINES TO EQUIPMENT

Tubing, piping and associated fittings connecting optimized water lines to equipment should be food grade material that meets NSF Standards 51 or 61 with a minimum pressure rating of 100 psi.

Optimized water may react with most metal piping imparting a bad taste. Plastic pipe or reinforced opaque beverage tubing are acceptable choices for optimized water distribution. A 1/2" or larger inside diameter tubing or hose will minimize pressure drop.

## ITEMS REQUIRED FOR INSTALLATION

In most cases, common hand tools and plumbing materials suitable for use with potable water are all that is needed for system installation. The system setup and calibration requires special equipment:

- Two - 32 ounce or 1,000 ml graduated containers
- Stopwatch
- Air pressure gauge
- Bicycle tire pump with Schrader valve
- TDS meter
- Tube cutter
- Pencil or pen
- 5.25% household bleach or equivalent disinfectant
- Full flow ball valve with 1/2" female NPT thread
- Phillips head screwdriver
- PTFE tape
- Adjustable wrench
- Cable ties
- Air gap accessory (optional)
- 1/4" tubing clamps (included)
- Food grade (NSF) plumbers grease,
- 5 gallon bucket (recommended for flushing)
- Four wall anchors to support processor adequately for the installation area walls (included for drywall with wood studs)  
**OR** clean surface on which to place the processor in (optional) stand

**NOTE:** Consult with your local building inspector for approval and required permits to install this system. Additional equipment may be required. Installation must meet all local and national codes.

## USING PUSH-TO-CONNECT FITTINGS

Get to know how to use the tubing connections before going forward.

### Fitting Overview

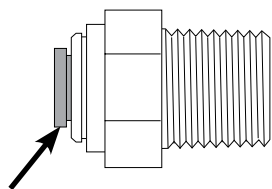

Collet/Gripper (dark gray)

### Tubing Preparation

The tubing outside must be free of nicks or gouges.



Cut tubing with a proper tube cutter for a clean, round cut.



After cutting, make sure the end of the tube is round. Fix if needed.

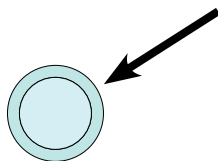

Mark on the tube the depth that it should go in. This will help you see when the tube is fully inserted.

Size and color of tube	Insertion depth to mark
1/4" black	1/2" to 5/8"
3/8" green	3/4" to 7/8"
1/2" blue	1" to 1-1/8"

### To Remove Tubing

Press collet in to release the grippers while pulling out the tubing.

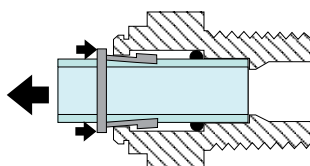

### To Attach Tubing

To lubricate, moisten end of tubing with fresh water.

Push tubing straight in.

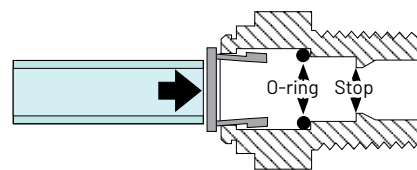

You will feel resistance when the tubing meets the O-ring.

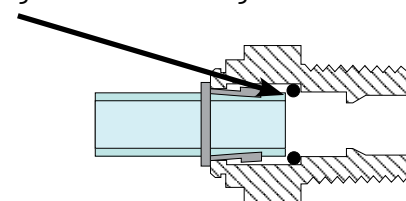

Keep pushing past the resistance until the tubing rests against the stop. Check the mark that you made on the tube to make sure the tube is inserted far enough.

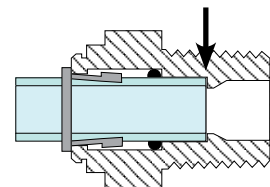

## WALL-MOUNT INSTALLATION

Locate system near electrical outlet, equipment, drain, and water source.

- Do not block access to controls and filters.
- Leave at least 3" clearance below the cartridges for removal.
- Mount processor where it is well-supported.
- Using appropriate wall anchors or screws, fasten anchors into concrete or screw directly into studs beneath wall board. If using concrete fasteners, follow manufacturer's instructions.

**NOTE:** If mounting on drywall, locate studs. Make sure that at least two of the anchors will be fastened into a stud.

1. Remove RO processor top cover by loosening Phillips screw in the back. Using a level, draw a line where the top or bottom of the bracket will be. Hold the RO processor on the line in the position it will be mounted and mark the four holes on the bracket.
2. Secure RO processor to wall using appropriate wall anchors. Put in screws with enough clearance to install the bracket.
3. How to use the supplied drywall/stud anchors:
  - a. Using #2 Phillips screwdriver, press drywall/stud anchor tip slightly into drywall. Applying pressure, turn anchor. If wood stud is hit, increase pressure. Continue turning anchor until flush.
  - b. Insert screw into anchor and mostly screw it in.

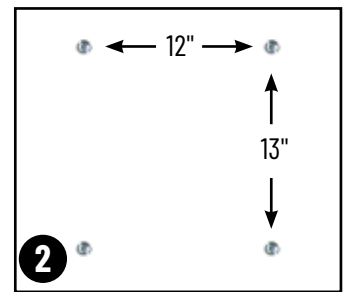
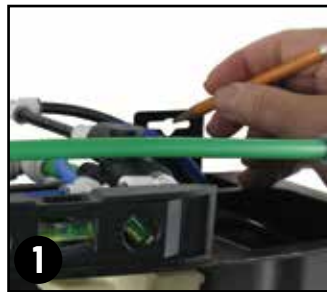

4. Hook processor over all four screws.
5. Slide processor to one side and tighten screws.
  - You can leave cover off until final flushing.



## OPTIONAL FLOOR STAND MOUNT INSTALLATION

Locate system in a secure location that's near electrical outlet, equipment, drain, and water source.

The floor stand kit part number is: EV315968.

- Do not block access to controls and filters.

1. Remove RO processor top cover by loosening Phillips screw in the back. Note the screw slots and tabs on the floor stand.
  - On 375 models (size 4 cans: 14.5" long) use the **lower** tabs and screw slots.
  - On 650 models (size 7 cans: 20.75" long) use the **upper** tabs and screw slots.
2. Hook the appropriate two slots on the back of the processor over two tabs on the floor stand.
3. From the back of the stand, screw the stand and processor together.
  - You can leave cover off until final flushing.

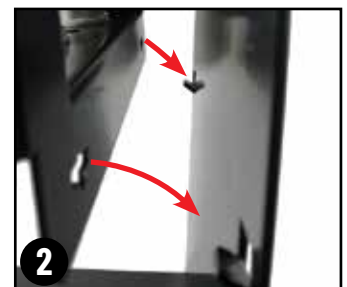



## CONNECT TUBING

### NOTE:

- Follow instructions from “Using Push-to-Connect Fittings” (page 7) when connecting tubing to fittings.
- At the connections ensure the tubes are cut as straight as possible.
- Elbows are included in the optional floor stand kit to keep the tubing from bending too much, therefore preventing leaks.
- Locate the tank close to the processor, a distance of 10 feet or less.

### Inlet Tubing Connections (3/8" Green Tubing)

1. Install 3/8" **green** tubing to FEED WATER IN port at bottom of RO processor.
2. Turn off incoming water supply at valve. Apply three wraps of PTFE tape to NPT threads of 1/2" NPT x 3/8" push to connect. Screw in fitting to NPT threads on water supply valve; hand tighten and tighten to no more than 2ft lbs of torque. Leave enough tubing for servicing and cut tubing to length. Insert other end of 3/8" **green** tubing to 3/8" PTC fitting installed on incoming water supply.

### Drain Tubing Connections (1/4" Black Tubing)

3. Install 1/4" **black** tubing to REJECT WATER OUT port.
4. Cut tubing to length and install the other end of the 1/4" **black** drain tubing to an air gap compliant with local codes.  
Air gaps are available from Pentair.  
(optional part no. 164-89905)
5. Install the air gap to a drain pipe. Securely fasten tubing as permeate pump will cause drain line to kick.

### To Tank Tubing Connections (3/8" Blue Tubing)

6. Install 3/8" **blue** tubing to the TO TANK port on the RO processor.

### Install Tee with Tank Sampling Valve

7. Install a tee with a sampling valve in a convenient location on the 3/8" blue line you just installed. This will be used to sample the water going to the tank and used for flushing the cartridges. Make sure the valve is closed and the end of the tube stays clean.
8. Run other end of 3/8" **blue** TO TANK tubing to sink or drain.
  - Connection to ATM tank will follow flushing process.

**NOTE:** Make sure outlet tubing will not come dislodged from drain or sink. Water flow rates can cause the tubing to kick.

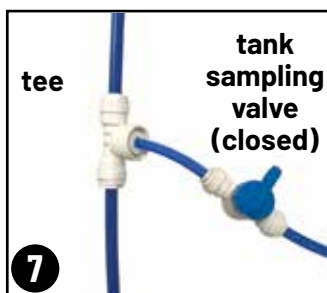
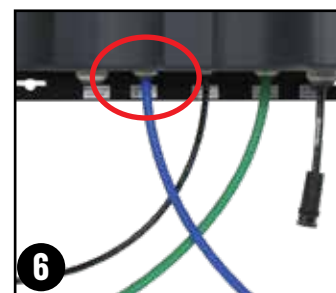
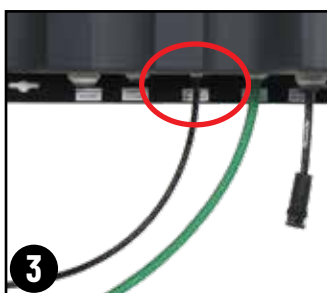
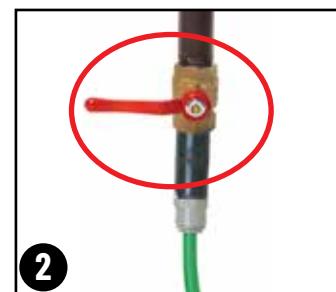
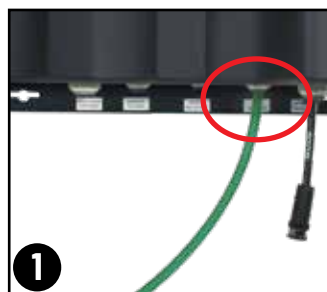

## CONNECT TUBING (CONTINUED)

### Return from ATM Tank Tubing Connections (1/2" Blue Tubing)

9. Install 1/2" **blue** tubing to the RETURN FROM ATM TANK port on the RO processor.
10. Cut tubing to length, to make connection to tank, allowing some slack for maintenance of system and tank. Install other end of 1/2" **blue** tubing into ATM TANK OUTLET valve on tank. Make sure tubing is inserted past second o-ring in fitting.

**NOTE: Cut tubing with a proper tube cutter for a clean, round cut.**

### If Using the Outlet Tubing Connection (1/2" Gray Hose)

11. Slide band clamp onto the 1/2" **gray** tubing. Insert 1/2" hose barb adapter into the tube. Slide band clamp close to end of tube and firmly tighten screw.
12. Make sure ATM TANK OUTLET valve is open.
13. Connect 1/2" adapter and hose assembly into OPTIMIZED WATER OUT port on RO processor.
14. Run other end of the **gray** optimized outlet tube to a **clean** sink or drain.

**IMPORTANT: Do not connect tube to equipment yet.** Connection to equipment will follow flushing process.

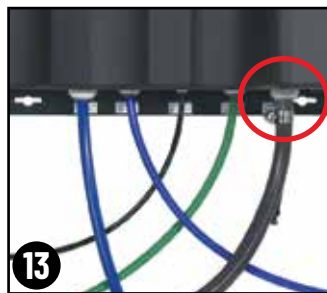
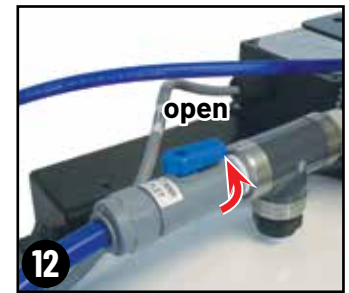
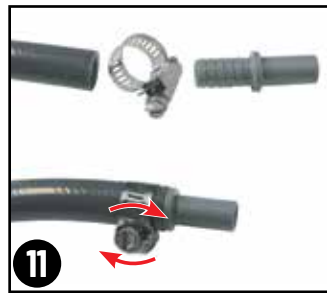
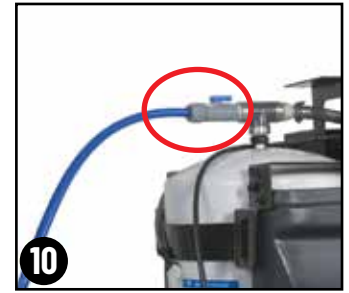
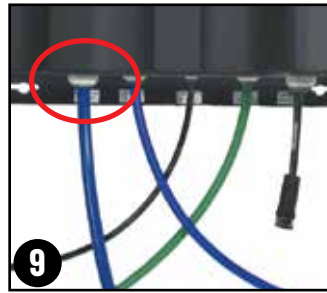

## ATTACH SOLENOID CABLE AND POWER CORDS

1. Connect M12 connector cable from ATM tank to RO processor. This cable controls power to RO solenoid valve. Cable is 9 feet long. (An M12, 2 pin connector can be used for extensions if required, not included.)
2. Connect power supply to power supply cord on the ATM Tank.
3. Securely mount the power supply block in a dry location. Wrap supply block with two zip ties (included) and screw zip ties to wall. Ensure cord length can reach wall outlet.

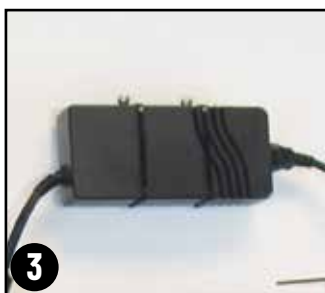
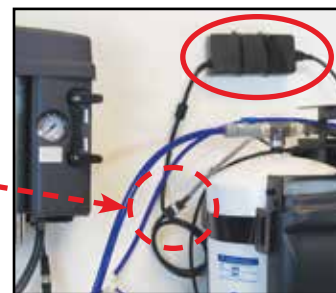
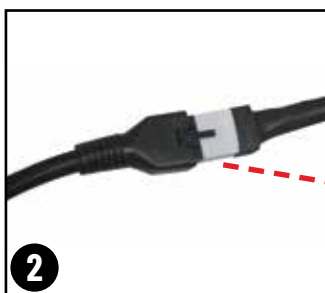
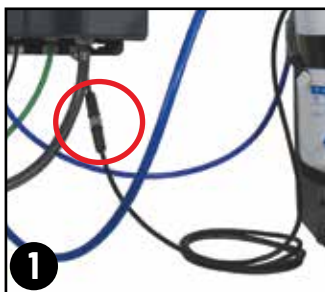

**IMPORTANT: Do not plug in to power yet.**

## OVERALL VIEW OF COMPLETED INSTALLATION



# SYSTEM STARTUP AND FLUSHING PROCESS

## REJECT FLOW RESTRICTOR SELECTION

1. Install prefilter into far left position and mineral addition cartridge in middle position. Align cartridge lugs with heads in bracket. Press up and twist a quarter turn.
2. Make sure the membrane plug is installed.

The processor comes with a pre-installed standard reject flow restrictor (**gray**). Water conditions and RO membrane filter size will determine what color flow restrictor may be required to have your EZ-RO system operating the most efficiently.

Record the feed water conditions of incoming TDS measured in ppm (parts per million) and the incoming water pressure measured in psi. Then see the "Reject Flow Restrictor Chart" on page 13. Follow chart per system size EZ-375 or EZ-650.

If the chart recommends using the **gray** flow restrictor, skip steps 3 through 6.

3. The reject flow restrictor that will need to be replaced is located on the left side of the 1/4" Tee fitting on the top of the processor connected to the black tubing.
4. Press the gray collet into the fitting and pull the left **black** tube away from the 1/4" Tee fitting. See "Using Push-to-Connect Fittings" on Page 7. Pull out the **gray** capillary flow restrictor. This task may require small pliers.
5. After reviewing the "Reject Flow Restrictor Chart", choose from the bag located with the manual the color of flow restrictor that best fits your water requirements. Colors included: **green, blue, white, orange.** (**Gray** is pre-installed.)
6. Insert the selected flow restrictor into the 1/4" **black** tubing. Firmly insert **black** tubing into 1/4" Tee fitting.

## FLUSHING PRE FILTERS

7. **Open** the reject flush valve.  
It's the side **middle blue** handle.  
**Open = pointing down.**
8. Check to make sure the permeate sample port valve is in **closed** position.  
It's the side **bottom blue** handle.  
**Closed = pointing left.**
9. Turn the RO processor valves to the following positions:  
**Inlet valve:** top black handle **pointed down** (open).  
**Outlet valve:** bottom black handle **pointed to right** (closed).
10. Turn on incoming feed water from source. After step 11 connecting to power:

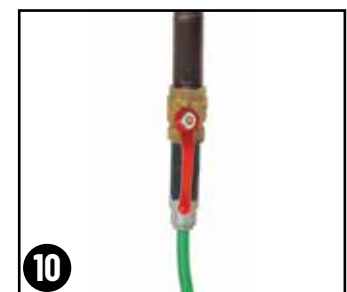
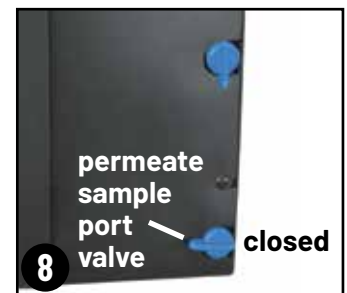
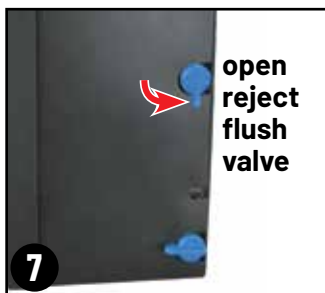
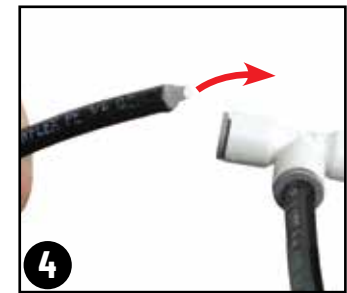
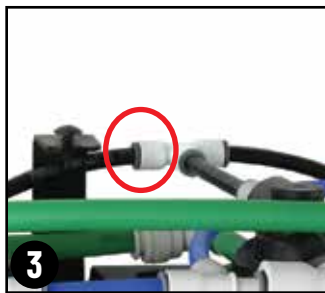

- Water will begin to fill RO processor and prefilter.
- Pressure gauge will show increase pressure.
- Check for any leaks. Shut off incoming water and repair leaks if required. Restart step 10.



## SYSTEM STARTUP AND FLUSHING PROCESS (CONTINUED)

11. Connect tank power supply to wall outlet.
12. Check system status light: yellow indicates tank is at low level.
  - RO Processor will power solenoid and water will begin to flow from drain and through the TO TANK line that is secure in the sink.
  - Check for any leaks. Shut off water and repair leaks if required. Turn incoming feed water back on when corrected.

**NOTE:** The pump might turn on quickly and then it should turn off. If pump continues to run, disconnect power, check ATM tank to ensure the low level sensor is connected and no water is in tank. Reconnect power. See Troubleshooting.

### 5 MINUTE FLUSHING OF PREFILTER AND MINERAL ADDITION CARTRIDGE.

13. Flush prefilter and mineral addition cartridge for five minutes or until water runs clear.
  - With power on, and solenoid valve open, flushing will proceed through reject outlet and through TO TANK port at this time.

### REMOVE SYSTEM PRESSURE

14. Turn off incoming feed water from source.
15. Pressure should drop to 0 psi.

**NOTE:** Leave power on.

### REJECT FLOW RESTRICTOR CHART

EZ-375 RO Module - Reject Line Flow Restrictor Guide ATM Systems			
RO Permeate Production Rate	High	Medium	Low
<b>FEED WATER TDS / PPM</b>	psi greater than 70 or LpM greater than 0.75	psi between 50 & 70 or LpM between 0.5 & 0.75	Low Pressure / Low Temperature LpM Less than 0.50
Soft Water & >300	WHITE 1.052 LpM	BLUE 0.735 LpM	GREEN 0.525 LpM
300 to 800	WHITE 1.052 LpM	WHITE 1.052 LpM	BLUE 0.735 LpM
800 to 1200	GRAY 1.577 LpM*	GRAY 1.577 LpM*	WHITE 1.052 LpM

EZ-650 RO Module - Reject Line Flow Restrictor Guide ATM Systems			
RO Permeate Production Rate	High	Medium	Low
<b>FEED WATER TDS / PPM</b>	psi greater than 70 or LpM greater than 1.4	psi between 50 & 70 or LpM between 0.9 & 1.4	Low Pressure / Low Temperature LpM Less than 0.90
Soft Water & <300	GRAY 1.577 LpM*	WHITE 1.052 LpM	BLUE 0.735 LpM
300 to 800	GRAY 1.577 LpM*	GRAY 1.577 LpM*	WHITE 1.052 LpM
800 to 1200	ORANGE 2.000 LpM	ORANGE 2.000 LpM	GRAY 1.577 LpM*

\*GRAY 1.577 LpM flow restrictor comes pre-installed in RO processor.

Production rate can be between High/Medium/Low caused by water temperature, incoming pressure (psi), and TDS of water. NSF testing completed at influent water conditions of 750 ppm TDS and at 50 psi water, using reject flow restrictor as indicated.

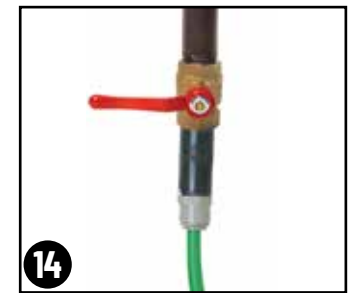
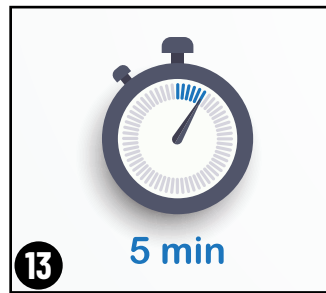
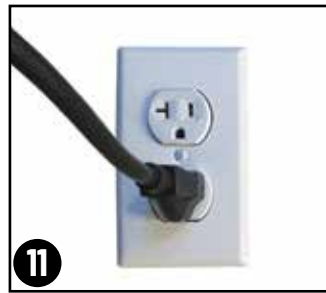

FLUSH

FLOW RESTRICTOR

## TWENTY-FOUR HOUR MEMBRANE FLUSH

1. Make sure system pressure is down to 0 psi.
2. Remove the membrane plug. Rotate left and pull down.
3. Store plug under system cover for future use.
4. Install supplied RO membrane cartridge (EZ-375 or EZ-650) into the farthest right position.
5. Turn on incoming feed water from source.
  - Water will begin to fill the RO processor.
  - Water will start to run from reject outlet at full flush and TO TANK port tubing.
  - Ensure both lines are secure with water flowing to drain or sink.
6. Flush the system through reject outlet and TO TANK port for **one hour**.
7. After one hour **close** the reject flush valve. It's the side middle **blue** handle.

**Closed = pointing left.**

8. Continue to flush for another 23 hours.
9. Recommended: Using a graduated cylinder, record the optimized water flow and reject flow in ounces/minute or ml/minute. Fill the graduated cylinder for one minute for each.

**Record the values here:**

Optimized water \_\_\_\_\_ oz. or ml \_\_\_\_\_ /min

Reject water \_\_\_\_\_ oz. or ml \_\_\_\_\_ /min

**NOTE:** Reject water volume in one minute will probably exceed 32 oz./1,000 ml. Use a large container or collect samples in multiple containers and add all of the collected volumes together.

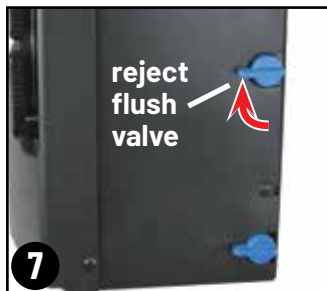
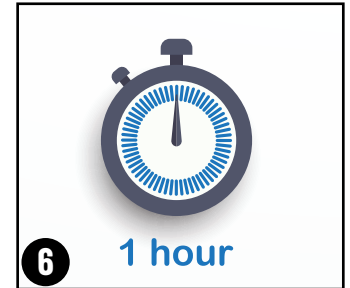
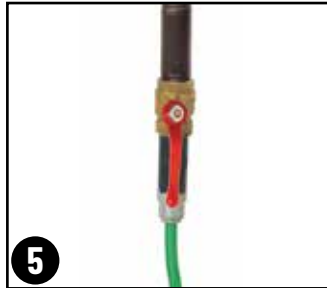
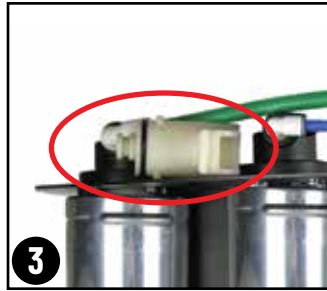
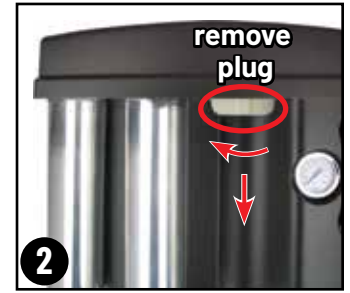

## ATM TANK FILL AND PUMP STARTUP

1. After 23 hours, stop system flush by closing inlet valve: rotate 90 degrees so that it points to the right.
2. Run 3/8" **blue** TO TANK tubing line to TANK INLET through bracket so tank cover will close correctly. Cut tubing to length allowing some slack for maintenance of system and tank.
3. Install the end of the 3/8" **blue** TO TANK tubing line to atmospheric tank ATM TANK INLET.
4. On RO processor, turn inlet valve to open position (pointing down).
5. On tank, open ATM TANK INLET valve. Check for any leaks at inlet valve or float switch. Repair if required.
6. Unplug tank power supply.
7. Open the ATM tank's 6" lid/access port and insert optimized outlet 1/2" gray hose into tank to add water to the ATM tank.
8. Turn the inlet valve and outlet valve to bypass position (both pointing to the right). Hold hose securely.
9. Add water to the tank until it is 1/4 full.
10. Once ATM tank is filled to approximately 1/4 full, open inlet valve (pointing down) on the RO processor. Water should stop flowing from gray hose. Reattach gray hose to clean sink for flushing the buffer tank.

**IMPORTANT: Keep outlet valve on the RO processor in closed position (pointing to the right).**

11. Connect power supply to wall outlet.
  - Pump should begin to run and will flow water from the pump into the buffer tank. The ATM tank systems status should show a flashing **green** light. Check to make sure ATM tank outlet valve is in the open position.
  - If light is **flashing yellow**, there is a possibility that the low level sensor did not recognize water at first power up. The flashing yellow light will flash for five minutes then pump will activate again.
  - If light is **solid yellow**, that indicates that the low-level sensor does not see any water and the tank will need to be filled higher before the pump will activate.
  - Pump will shut down when buffer tank and line reach 60 to 70 psi of pressure.

**NOTE:** It could be helpful to quickly open and close the outlet valve on the RO processor to release any trapped air in line. Two to three times should be fine. Release trapped air and water out of the optimized outlet 1/2" gray tubing into the drain or sink.

- Water will be filling the ATM tank now also from RO processor. When filling without pump, system status light will be **blue**.

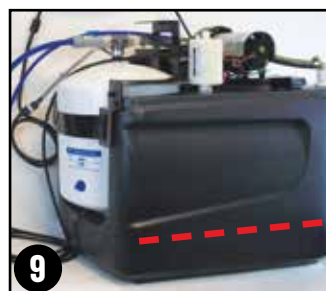
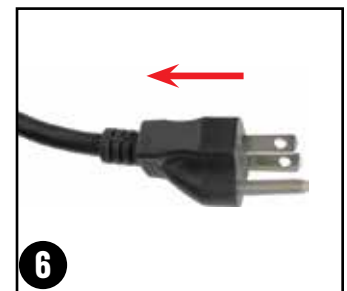
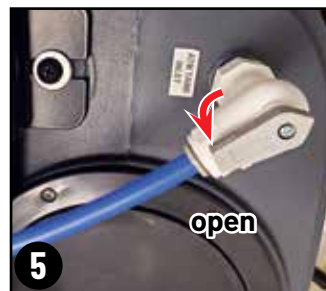
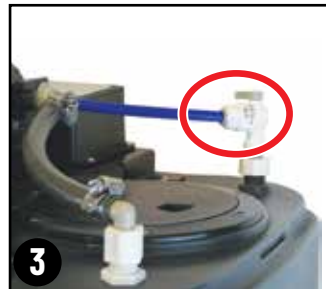
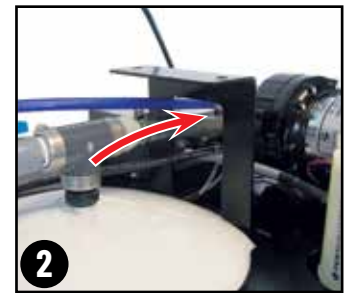
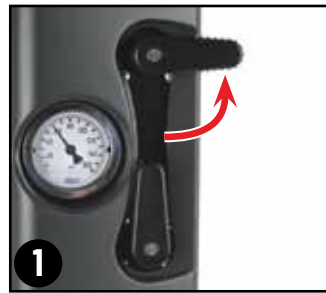





## FLUSH BUFFER TANK (CONTINUED) CONNECT TO EQUIPMENT

9. Let ATM fill until tank is full. ATM tank system status light turns from **blue** to **green**.
10. Repeat Steps 6 through 8 for final flush of ATM tank.

### CONNECT TO EQUIPMENT

11. Attach garden hose fitting to 1/2" hose.
    - If garden hose connection is not required – use alternate connection to 1/2" ID tubing (not included).
    - If using garden hose fitting to 1/2" hose, secure with clamp.
  - a. Separate the hose barb adapter into three parts: threaded fitting, barbed flange, gasket. Slide band clamp onto hose first and threaded fitting second.
  - b. Insert barbed flange into hose.
  - c. Push until edge of flange is flush with hose tip.
  - d. Insert gasket into threaded fitting.
  - e. Slide band clamp to end of hose and tighten screw.
12. Open outlet valve on RO processor to allow optimized water to enter equipment.
    - Water will begin to enter equipment.
    - Complete final check for leaks.
    - Reinstall ATM tank cover and 6" access lid.

### SYSTEM INSTALL AND FLUSHING COMPLETE.

Treated water is in use at equipment.

- It may take several hours to completely fill the tank and fully pressurize the system. Make sure to check for leaks when fully pressurized.

**NOTE:** The tubing/piping and associated fittings connecting the RO water outlet to the equipment being serviced should be food-grade material that meets NSF® Standard 51, 61, or similar, with a minimum pressure rating of 100 psi (6.9 bar, 0.69 MPa). The RO water may react with metal piping, creating a corrosive condition in addition to imparting an objectionable taste. Plastic pipe or reinforced beverage tubing are generally very good material choices for RO water distribution piping. The size of the water tubing/piping should be 1/2 inch (12.7 mm) O.D. minimum.

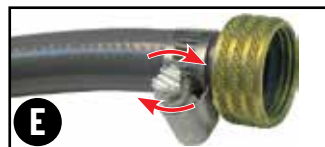
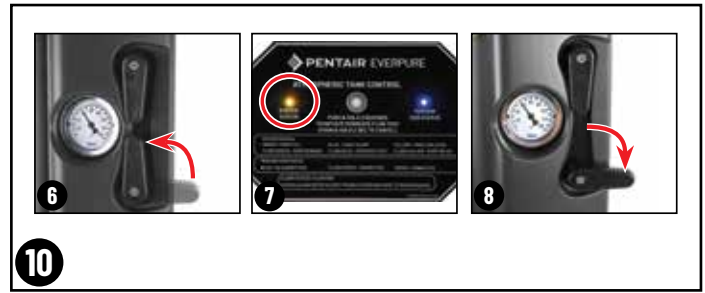

# FILTER CHANGE AND FLUSHING PROCEDURE

**RECOMMENDED:** Replace mineral feed cartridge every 6-12 months. For 375 systems use 4CM cartridge. For 650 system use 7CM cartridge. RO membranes should be replaced every 12-24 months. Prefilters should be replaced every 4-6 months when capacity is reached, or when feed water pressure or flow becomes inadequate.

**RECOMMENDED:** Replace air filter on the ATM tank every 12 months.

## REMOVE SYSTEM FROM INCOMING PRESSURE

**NOTE:** Following this process will allow water remaining in ATM Tank to continue to supply water to equipment.

1. Turn inlet valve right to the OFF (horizontal) position.

**NOTE:** Feed water is shut off to filters in this "filter change" position.

2. On the ATM tank, close ATM TANK INLET valve.

3. To catch water from sample port valve, place bucket beneath processor. Release system pressure, open sample port valve (pointing down).

**NOTE:** The ATM system requires the solenoid to be open to remove pressure. If tank water level is low or the system status light is **blue**, the ATM tank is filling with water and the solenoid is activated. Initiating a permeate flow test is not required.

4. If system status light is **green**, press and hold the white button on the electronic control box for two seconds. This will open the solenoid.

## REMOVE FILTERS

- 5. Make sure incoming pressure is at 0 psi.
- 6. Turn filters 90 degrees to left, pull down to remove.

## REPLACE PREFILTER AND MINERAL ADDITION CARTRIDGES, ADD PLUG TO MEMBRANE PORT

- 7. a. Add new prefilter to position 1 (insert and turn 90 degrees to right).
- b. Add new mineral addition cartridge to position 2 (insert and turn 90 degrees to right).
- c. Add RO membrane bypass plug (stored under cover) to the farthest right position (insert and turn 90 degrees to right).

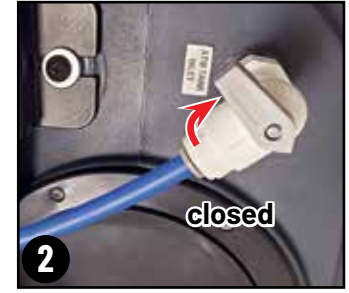
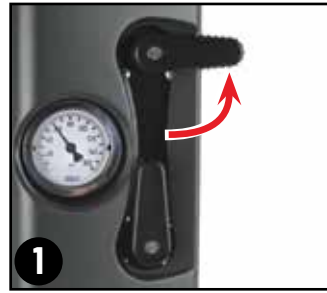

FILTER CHANGE

## FILTER CHANGE AND FLUSHING PROCEDURE (CONTINUED)

### FLUSH PREFILTER AND MINERAL CARTRIDGES

8. Turn reject flush valve to open position (pointing down).
9. Close the permeate sample port valve (pointing left).
10. On the TO TANK LINE – Run Tee sample line into bucket or drain. Open tee sample port. Water will flush out of this line.
11. Turn inlet valve to open position.
  - Water will start to fill prefilter and mineral cartridges. Water will run from reject/sample port and tank sampling valve.
  - The solenoid valve needs to remain open; a permeate flow test may be required again if the ATM system status light is **green**. See image 4.
12. Flush prefilter and mineral addition for five minutes or until water runs clear.

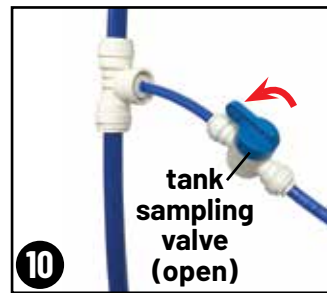
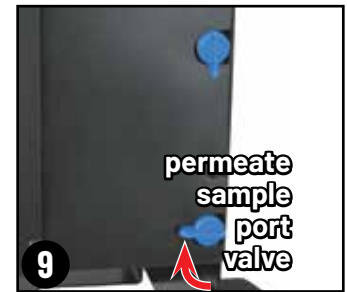
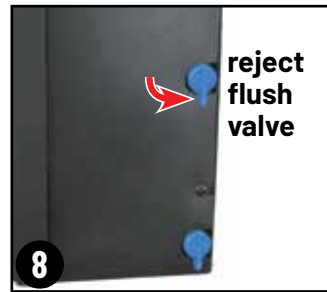

### RETURN EXISTING RO MEMBRANE OR REPLACE WITH NEW RO MEMBRANE (IF REQUIRED)

13. Turn processor inlet valve to closed position (horizontal).
14. The pressure gauge will reduce to 0 psi.
15. Remove membrane bypass plug (turn 90 degrees, left and pull down). Store under cover.
16. Insert RO membrane into the farthest right position (insert and turn 90 degrees to right).
17. Turn inlet valve to open position (vertical).
  - Water will start to flush through membrane. Water will run from reject and TO TANK line sample port when solenoid valve is still open.

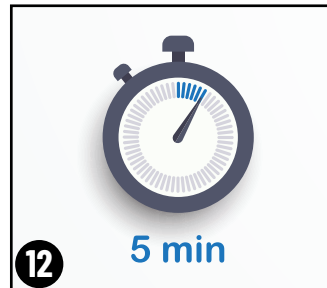

FILTER CHANGE

**IF REUSING EXISTING MEMBRANE, SKIP TO STEP 22**

## FILTER CHANGE AND FLUSHING PROCEDURE (CONTINUED)

### FLUSH NEW MEMBRANE

**Before flushing new membrane:** The ATM tank requires water level to be low indicated by a **blue** ATM system status light. This requires the solenoid valve to remain open during the flush time.

- Ensure tank inlet valve is closed as in step 2 (page 18).
- Ensure the TO TANK LINE Tee sample line is open and running to a drain as in step 10.

18. Put system into partial bypass to continue to supply feed water to equipment during membrane flush:

- Turn inlet valve 45 degrees.
- Turn outlet valve to the right.

**NOTE:** Partial bypass allows feed water to go to equipment and also allows water to flush RO membrane.

19. Continue to flush membrane for one hour with reject flush valve open.

20. After one hour close reject flush valve.

**Closed = pointing left.**

21. Continue to flush membrane for 23 hours.

**NOTE:** Permeate water can be flushed through the tank sampling port. You can run additional tubing from the tank sampling port to a drain.

### RETURN RO SYSTEM TO NORMAL SERVICE

22. After new membrane flush, or initial flush of existing membrane (step 17) ensure reject flush valve (step 20) and all sample ports/valves are closed.

23. Ensure system inlet and outlet are returned to service positions. Inlet (pointed down), outlet (pointed up).

24. On ATM tank, turn ATM tank inlet valve to open position to allow water to enter ATM tank.

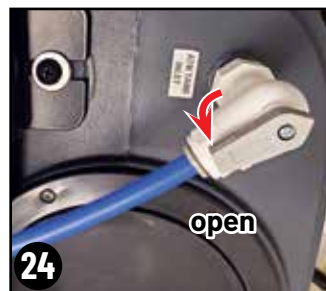
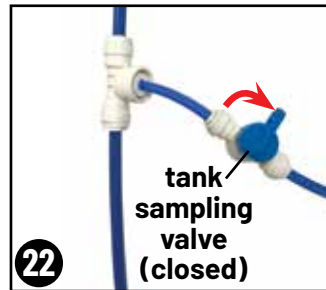
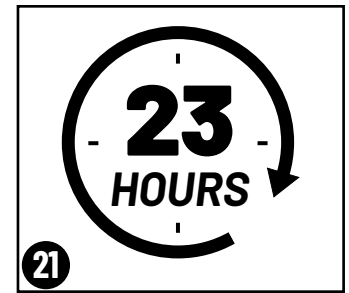
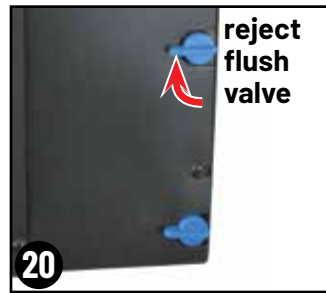
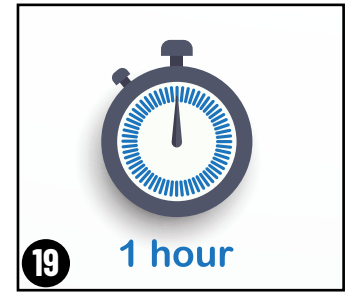
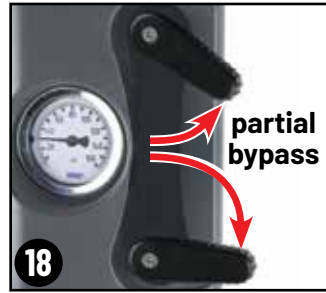

**Filter change and flushing complete.**

Optimized water is now in use at equipment.



## TROUBLESHOOTING

Problem	Possible Cause	Solution
<b>No water running to equipment.</b>	Water supply is turned off.	Turn on the water.
	Water supply is blocked. Prefilter is plugged.	Clear blockage. Change prefilter.
	Membrane cartridge is fouled.	Replace membrane cartridge.
	Incoming water line is crimped or pinched off.	Check incoming line and verify no crimps in line. Remove any pinch points.
<b>Running out of optimized water</b>	Operating pressure reduced	Prefilters need to be replaced.
	Very cold feed water	Feed water temperature too low, increase water temperature up to 80°F to increase production with tempering valve or check if larger RO membrane or tank can be added.
	Valves are in incorrect positions	Ensure the inlet valve and outlet valve on the RO processor are open. See hang tag for normal operation. On the atmospheric tank, ensure the inlet valve is open and the buffer tank outlet valve is open.
	Atmospheric tank not working- No power	See "Repressurization pump does not turn on" page 22.
	Demand exceeds system capacity	Check RO permeate flow. Water temperatures of 48°F will reduce permeate output by 50%. Inlet pressures of 30 psi will reduce permeate output by more than 50% compared to 60 psi inlet. Consult with technical support if permeate flow is too low. Determine if the demand is unusual or inconsistent, or resize system with higher capacity membrane and/or tank.
	Atmospheric tank -Low water level- Atmospheric tank system status yellow or flashing yellow	If system status is yellow, water will need to fill to minimum level. After water refills tank above low level sensor, the status light will flash yellow and the repressurization pump will start after 5 minute delay.
	Atmospheric tank- Repressurization pump running, but not pumping water	Pump is air locked. Remove outlet pressure from pump by draining outlet to reprime pump.
	Reverse osmosis membrane fouled	Replace reverse osmosis membrane every 12-24 months. See "Short membrane life" page 22 for additional information.
Low feed water pressure	Install optional feed water pressure booster pump to get pressure up to 60-80 psi. Check outlet pressure of existing booster pump if already installed.	
<b>Tank overflowing</b>	High level sensor and tank float shut-off failing	Check sensor connection, verify if connected to wire harness. Replace if needed. Open tank cover and check float shut-off by raising float; replace if necessary.
<b>Low TDS rejection &lt;75%</b>	Inlet and outlet valve not in normal operation	See Hang tag for normal operation. Measure reject flow rate and compare to reject flow restrictor chart on page 13. Replace prefilter, capillary flow control and RO membrane as needed. When moving inlet and outlet handles from bypass to service positions, you may detect a pressure imbalance that prevents the outlet handle from reaching full final position. Correcting this issue by turning the valve outlet or inlet handles open and closed again, will help equalize pressure to allow inlet and outlet valves handles to fully engage to the service position.
	Membrane failure	Measure TDS out of permeate sample port. Measure reject flow rate. Replace prefilter and RO membrane as needed. Check to see if the capillary flow control is plugged. Replace capillary flow control as needed.
<b>Nonblended optimized water &lt;25 ppm</b>	Mineral feed cartridge exhausted	Replace mineral feed cartridge with 4CM for 375 system, 7CM for 650 systems every 6-2 months.

## TROUBLESHOOTING (CONTINUED)

Problem	Possible Cause	Solution
<b>Short membrane life</b>	Permeate /reject water ratio not adjusted correctly	Measure and adjust the reject flow rate per page 13.
	Poor feed water quality, presence of Hydrogen sulfide, iron, manganese, silica or hard water	Determine feed water quality by obtaining a water quality report from the city water supply utility or contact your Everpure dealer for a water test. See incoming water requirements on page 6.
	High chlorine levels in feed water	Contact your Everpure dealer for a recommended prefilter change schedule.
	Prefilter filtering capacity has expired	Change prefilter every 6 months or as needed.
<b>Short prefilter life</b>	Heavy sediment loading	Change prefilter more often or add an additional 10 micron coarse prefilter before system (E-10 10 inch filter EV9795-80 or E-20 20 inch filter EV9795-90).
<b>Processor drain does not shut off</b>	High level sensor malfunction	If water continues to flow to the drain after the tank is full and the system status shows a blue light (tank filling), this indicates the high level sensor does not detect water. Check to make sure that the high level sensor harness is connected correctly. Remove sensor and test it to see if replacement is required.
	Processor solenoid malfunction	If water continues to flow to the drain after the tank is full and the system status shows a green light (tank full), this indicates the RO processor solenoid valve is not closing. Disconnect the M12 connector cable from the RO processor to check if water continues to drain. If so, solenoid is stuck in open position. Service solenoid and replacement might be required.
<b>Tank full of water but water will not dispense</b>	Tank valve closed	Open tank valve.
	Pump failure	See "Repressurization Pump Does Not Turn On" below.
	Bladder ruptured	If tank does not hold precharge pressure or water is coming out of Schrader valve, replace tank.
<b>Repressurization pump does not turn on</b>	System status light off (on top of control box, under atmospheric tank lid)	If system status light is Off, ensure power cord is plugged into an outlet with power (check circuit breaker), and that water is in the tank. If LED will not turn On (with power and water in the tank), there may be a problem with the control. Contact your service provider for additional help.
	System status light is green or blue	Check power cable connections to pump. Check to make sure tank outlet valve is open and RO processor valves are in service positions. If pump continues to not run, call for service to replace pump.
	System status light flashing yellow or solid yellow	If Status LED is solid yellow, repressurization pump is off because of low water level. Allow processor to partially fill tank with water. Flashing yellow LED indicates repressurization pump will start after delay of five minutes and additional water will fill the tank. Pump will activate after delay and will turn off when the outlet line pressure reaches >60 psi or tank runs low of water and LED turns yellow.
	Repressurization pump brushes worn	Try bumping the repressurization pump with your hand. If it turns on temporarily the brushes are probably worn. Replace pump.
	Repressurization pump is damaged	Call for service to replace pump.
<b>Repressurization pump is leaking</b>	Possible seal wear or O-ring damage	Call for service to replace pump.
<b>Repressurization pump runs intermittently or roughly</b>	Air trapped in pump head	Unplug pump temporarily. Open valve downstream to remove outlet pressure from pump. Plug in pump to reprime pump. When water flow is steady, close valve downstream.
	Repressurization pump motor brushes worn	Call for service to replace pump.
	Bad power supply	Upon starting up the pump, the pump may struggle to start or fail to start. At the same time the system status light will start blinking red. Call for service to replace power supply.

## TROUBLESHOOTING (CONTINUED)

Problem	Possible Cause	Solution
Repressurization pump cycles on-off frequently	Low air precharge in buffer tank	Empty buffer tank and precharge air pressure to 20 psi through Schrader valve.
Low water pressure at water using equipment	Tubing between reverse osmosis system and equipment too small	Increase tubing size between reverse osmosis and equipment to 1/2" or larger.
	Incorrect precharge in tank	For atmospheric system, precharge tank to 20 psi when empty.
	Out of adjustment pressure switch on repressurization pump	Adjust pressure switch on repressurization pump to turn off at 60-70 psi.
	Bladder ruptured	If tank does not hold precharge pressure or water is coming out of Schrader valve, replace tank.
Objectionable water odor or taste	Storage tank requires sanitization	Sanitize storage tank. See tank sanitization section.
	Additional post filtration needed	Add additional carbon filtration on outlet of system.
Reject water flow rate too low or decreases over time	Drain line restricted	Check/correct any restrictions in drain line tubing, no loops or kinks. Make sure to allow an air gap at the drain. Close RO processor inlet valve, wait for pressure gauge to read zero, disconnect reject line at quick connect fitting and inspect for obstruction or damage. Remove obstruction. Replace tubing and capillary flow control as needed.
Reject water flow rate too low or decreases over time	Drain line restricted	Check/correct any restrictions in drain line tubing, no loops or kinks. Make sure to allow an air gap at the drain. Close RO processor inlet valve, wait for pressure gauge to read zero, disconnect reject line at quick connect fitting and inspect for obstruction or damage. Replace tubing and flow control as needed.
System status flashing red  To rule out these possible causes go through the following steps from A to D.	<b>A.</b> High motor current detected: short circuit	Disconnect motor cable connection. Open faucet downstream of tank. If ATM tank is empty, bypass water into tank until low level sensor is covered. Unplug tank from electrical outlet and plug back in. If error goes away, motor will need to be replaced. Contact your service provider. If error does not go away, plug in motor cable, and refer to "Short in solenoid or cable" in troubleshooting
	<b>B.</b> Short in solenoid or cable	<b>1)</b> Disconnect solenoid cable connection from solenoid valve. Unplug tank from electrical outlet and plug back in. Press and hold button on ATM controller for 2 seconds, if error goes away, processor solenoid will need to be replaced. Contact your service provider. If error does not go away, proceed to step 2. <b>2)</b> Disconnect ATM solenoid cable connection from the processor M12 solenoid cable connection. Unplug tank from electrical outlet and plug back in. Press and hold button on ATM controller for 2 seconds, If error goes away, processor solenoid cable will need to be replaced. Contact your service provider. If error does not go away, refer to water level sensor issue troubleshooting.
	<b>C.</b> Water level sensor issue	High level sensor senses water with low level sensor not sensing water. Ensure Low tank sensor is pressed firmly up against tank wall, Inspect low level sensor cable and connection, and/or replace low level sensor.
		Unplug and reconnect low level sensor connection. If error goes away, low level sensor may need to be replaced.
<b>D.</b> Controller issue	If error does not go away, remove power cord from outlet, power down system, and contact Pentair technical support.	
Pentair hub status LED is always blue	Pentair hub not present	The Pentair hub status feature is currently not available. The hub status LED can be ignored.

**Pentair® Everpure® Technical Support:**  
**Tel: 800.942.1153 (US Only) • 630.307.3000 Main • Email: [servicespecialist@pentair.com](mailto:servicespecialist@pentair.com)**

## ATMOSPHERIC WATER STORAGE TANK CLEANING GUIDE

**WARNING:** Wear protective gloves, protective clothing, face protection, and eye protection such as safety glasses.

**WARNING:** Do not breathe in fumes or drink water being treated with Dutrion tablets or bleach.

**NOTE:** Dosing recommendations are intended for routine maintenance. Visible bio-films will require manual removal/cleaning and additional tablets or bleach for treatment.

**DO NOT** use system until after you have thoroughly flushed the tank.

### CLEANING TANK WITH DUTRION TABLETS

**NOTE:** Do not leave open packet in tool box.

Do not keep packet if unsealed or open.

1. Make sure tank is 1/4 full of water.
2. Close ATM tank outlet valve.
3. Relieve pressure by opening a faucet or briefly running equipment that is using optimized water.
4. Put RO processor into bypass.
5. Drop tablets into tank and close lid.  
Depending on tank size use the recommended number of 4 gram Dutrion tablets.
  - 16 Gallon, 1 Tablet
  - 30 Gallon, 2 Tablets
  - 50 Gallon, 2 Tablets
6. Let tank sit with the LID CLOSED for 30 minutes to get full effect from Dutrion tablets.
7. Disconnect the 1/2" inch blue RETURN FROM ATM TANK tube at the RO processor connection. Attach additional length of 1/2" tubing to the end of the tube you just disconnected. Run that tube to the drain, keep it clean, and secure it while maintaining an air gap.
8. Open the tank outlet valve.
9. Move RO processor inlet valve to partial bypass position (45 degrees). Empty the entire tank. When tank is empty and system status is yellow, water will need to fill to minimum level. After water refills tank above low level sensor, the status light will flash yellow and the repressurization pump will start after 5 minute delay.
10. Allow repressurization pump to flush tank two more times. Rinse out tank with clean water.
11. You will have to disconnect "RETURN FROM ATM TANK" tube from drain. When nearly empty, using the "RETURN FROM ATM TANK" tube, spray the interior surfaces of the tank with water to assure a thorough rinse.
12. Reconnect "RETURN FROM ATM TANK" tube to RO processor.

**The system is now ready to be put back into normal operation.**

Part number for 4 gram tablet: 150-60024

### CLEANING TANK WITH BLEACH

1. Fill tank. Put RO processor into bypass if the tank isn't full already.
2. Close ATM tank outlet valve.
3. Relieve pressure by opening a faucet or briefly running equipment that is using optimized water.
4. Depending on tank size add the recommended amount of unscented chlorine bleach:
  - 16 Gallon, 8oz.
  - 30 Gallon, 15 oz.
  - 50 Gallon, 24 oz.
5. Let tank sit with the LID CLOSED for at least 20 minutes to get full effect from the bleach.
6. Disconnect the 1/2" inch blue RETURN FROM ATM TANK tube at the RO processor connection. Attach additional length of 1/2" tubing to the end of the tube you just disconnected. Run that tube to the drain, keep it clean, and secure it while maintaining an air gap.
7. Open the tank outlet valve.
8. Move RO processor inlet valve to partial bypass position (45 degrees). Empty the entire tank. When tank is empty and system status is yellow, water will need to fill to minimum level. After water refills tank above low level sensor, the status light will flash yellow and the repressurization pump will start after 5 minute delay.
9. Allow repressurization pump to flush tank two more times. Rinse out tank with clean water.
10. You will have to disconnect "RETURN FROM ATM TANK" tube from drain. When nearly empty, using the "RETURN FROM ATM TANK" tube, spray the interior surfaces of the tank with water to assure a thorough rinse.
11. Reconnect "RETURN FROM ATM TANK" tube to RO processor.

**The system is now ready to be put back into normal operation.**



# REPLACEMENT PARTS

Contact your local Pentair® Everpure® distributor for system replacement parts. To locate your distributor, call customer service at 800.942.1153 or 630.307.3000.

## CANISTERS

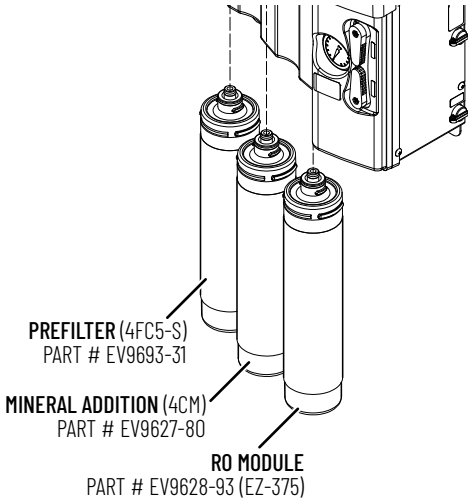

PREFILTER (4FC5-S)  
PART # EV9693-31

MINERAL ADDITION (4CM)  
PART # EV9627-80

RO MODULE  
PART # EV9628-93 (EZ-375)

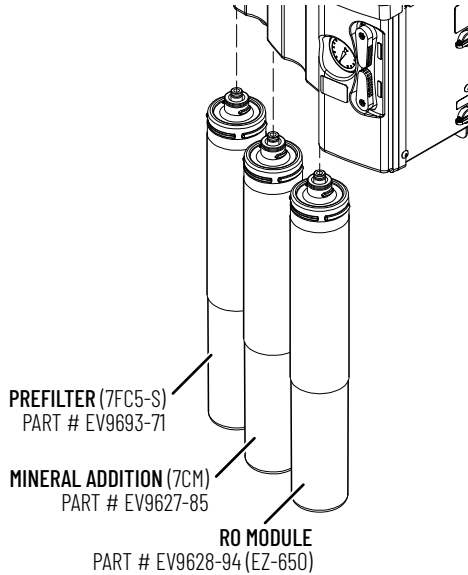

PREFILTER (7FC5-S)  
PART # EV9693-71

MINERAL ADDITION (7CM)  
PART # EV9627-85

RO MODULE  
PART # EV9628-94 (EZ-650)

## OPTIONAL STAND KIT

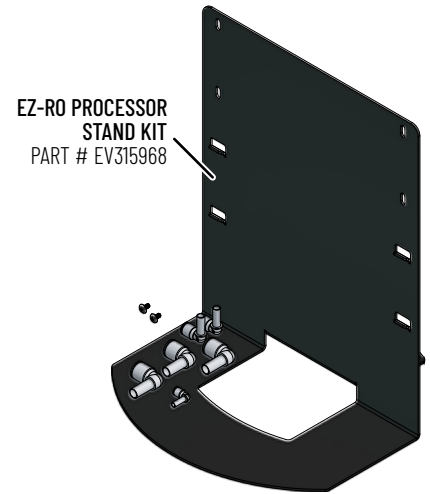

EZ-RO PROCESSOR  
STAND KIT  
PART # EV315968

## PROCESSOR PARTS

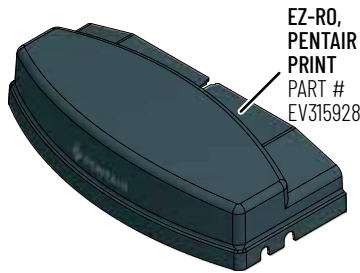

EZ-RO,  
PENTAIR  
PRINT  
PART #  
EV315928

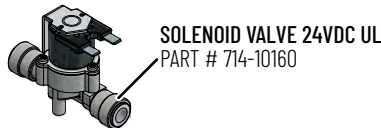

SOLENOID VALVE 24VDC UL  
PART # 714-10160

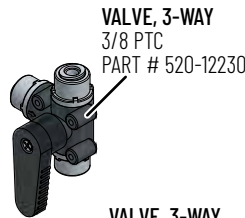

VALVE, 3-WAY  
3/8 PTC  
PART # 520-12230

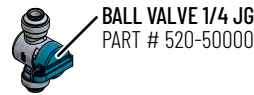

BALL VALVE 1/4 JG  
PART # 520-50000

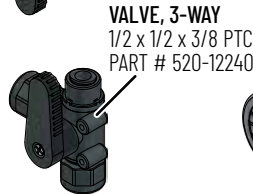

VALVE, 3-WAY  
1/2 x 1/2 x 3/8 PTC  
PART # 520-12240



PRESSURE GAUGE  
0-160  
PART # 530-20018

## TANK PARTS

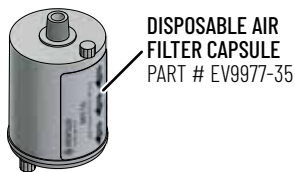

DISPOSABLE AIR  
FILTER CAPSULE  
PART # EV9977-35

PUMP DIAPHRAGM  
24VDC 70+ PSI  
PART # 704-35524

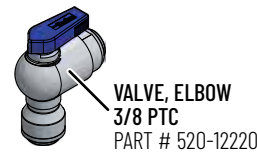
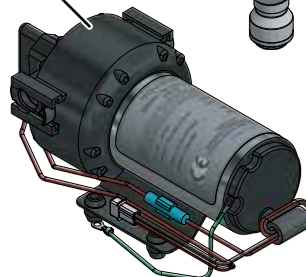

VALVE, ELBOW  
3/8 PTC  
PART # 520-12220

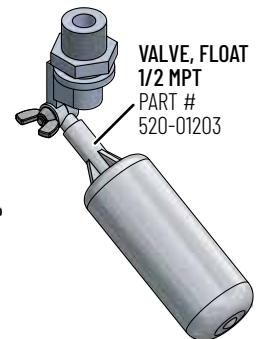

VALVE, FLOAT  
1/2 MPT  
PART #  
520-01203

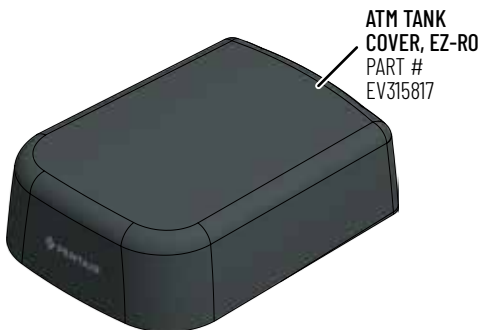

ATM TANK  
COVER, EZ-RO  
PART #  
EV315817

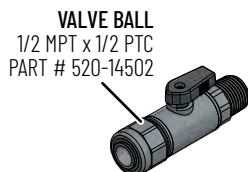

VALVE BALL  
1/2 MPT x 1/2 PTC  
PART # 520-14502



CAPACITANCE  
LEVEL SENSOR  
PART # EV315862



LID 6" ACCESS  
PLATE SET  
PART # 570-00190

REPLACEMENT PARTS

## DIMENSIONS

Processor with Size 7 Cannisters, Wall Mounted

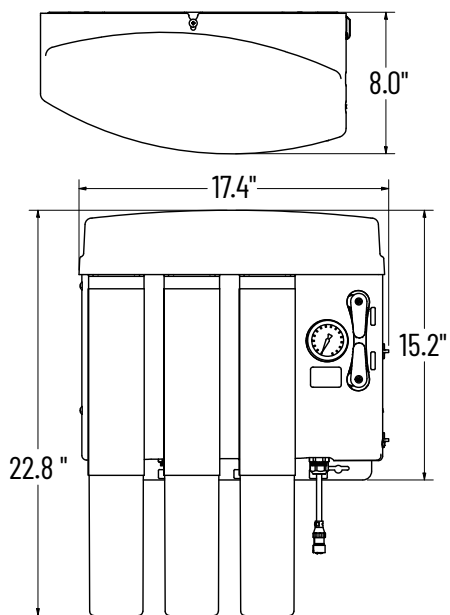

Processor with Size 4 Cannisters, Wall Mounted

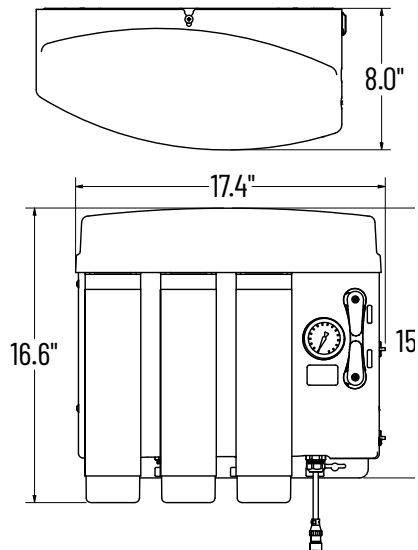

Processor with Size 7 Cannisters on Optional Stand

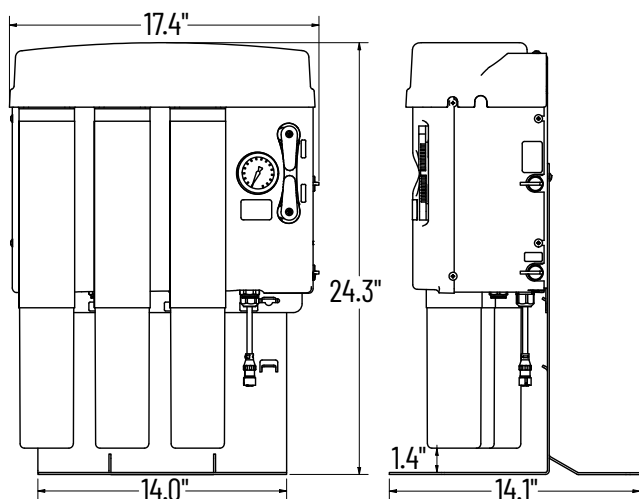

Processor with Size 4 Cannisters on Optional Stand

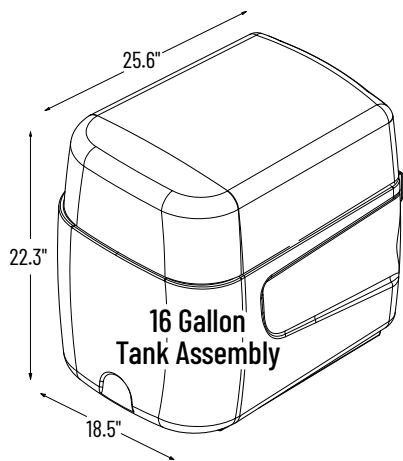
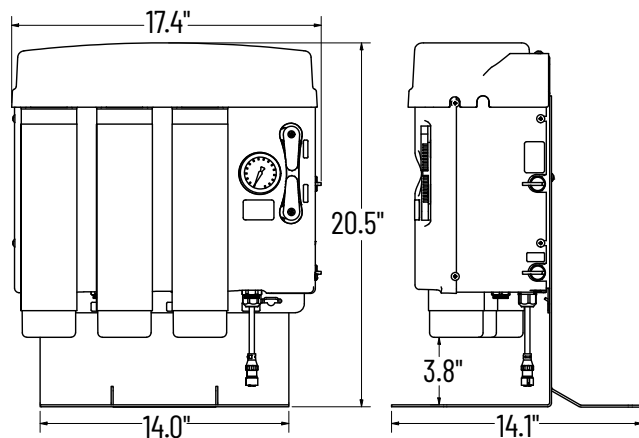

**16 Gallon  
Tank Assembly**

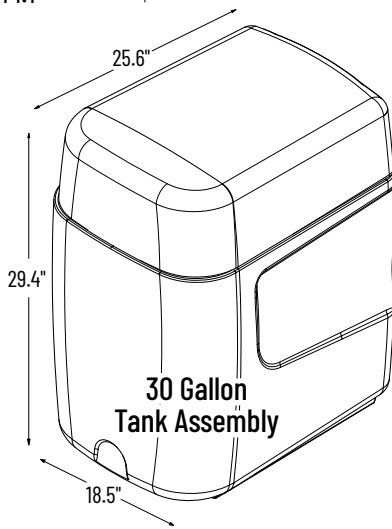

**30 Gallon  
Tank Assembly**

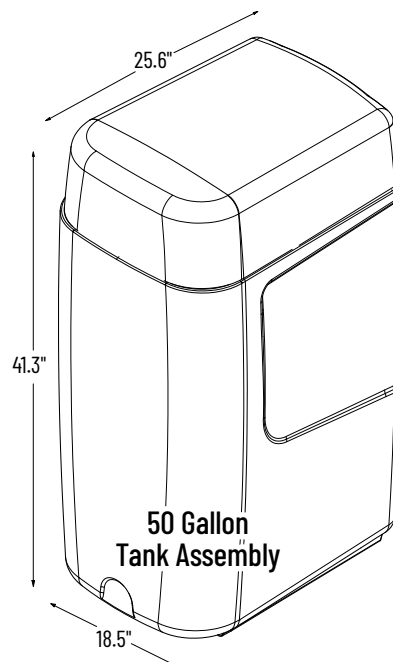

**50 Gallon  
Tank Assembly**

**EZ-RO 375/650 ATM SYSTEM  
PLUMBING**

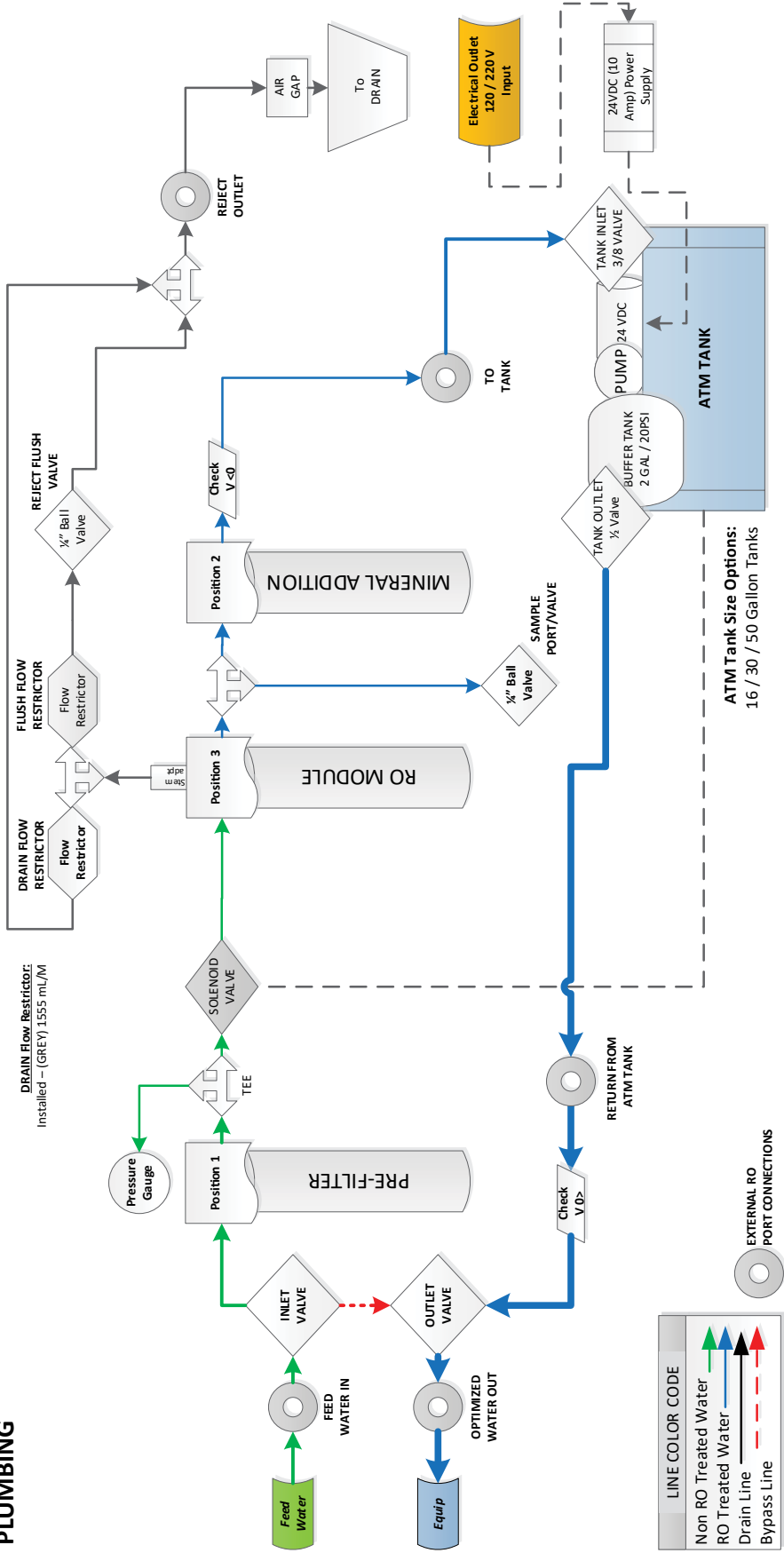



System is Tested and Certified by NSF International against NSF/ANSI 58 and CSA B483.1 for the reduction of Total Dissolved Solids (TDS).



Daily Production Rate: 268.39 gpd  
Efficiency Rating: 45.01%  
Recovery Rating: 41.54%  
Min/Max Working Pressure: 50 - 100 psi (3.5 - 6.9 bar), non-shock  
Min/Max Operating Temperature: 40 - 100°F (4.4 - 37.8°C)

Recovery rating means the percentage of the influent water to the membrane portion of the system that is available to the user as RO treated water when the system is operated without a storage tank or when the storage tank is bypassed.

Efficiency Rating means the percentage of the influent water to the system that is available to the user as RO treated water under operating conditions that approximate typical daily use.

**For Pentair Everpure product warranties visit:**  
<https://www.pentair.com/assets/foodservice-warranty>

**Numerous patents pending on technology and other aspects of the product design.**

**For Pentair patent information visit:**  
<http://pentair.com/patents>



**United States** | 101 S. Gary Ave | Roselle, IL 60172 | 800.942.1153 (US Only) 630.307.3000 Main | [cseverpure@pentair.com](mailto:cseverpure@pentair.com) | [foodservice.pentair.com](http://foodservice.pentair.com)

**Australia** | 1-21 Monash Drive | Dandenong South, Vic 3175 | Australia | 011.1300 576 190 Tel | [au.everpure@pentair.com](mailto:au.everpure@pentair.com)

**China** | 21F Cloud 9 Plaza, NO 1118 | Shanghai, 200052 | China | 86.21.3211.4588 Tel | [china.water@pentair.com](mailto:china.water@pentair.com)

**India** | Boulevard, B-9/A, 7th Floor - Tower B Sector 62 | Noida - 201301 | 91.120.419.9444 Tel | [indiacustomer@pentair.com](mailto:indiacustomer@pentair.com)

**Europe** | Pentair Water Belgium BVBA | Industriepark Wolfstee, Toekomstlaan 30, B-2200 Herentals | Belgium | +32.(0).14.283.504 Tel | [sales@everpure-europe.com](mailto:sales@everpure-europe.com)

**Japan** | Japan Inc. | Hashimoto MN Bldg. 7F, | 3-25-1 Hashimoto, Midori-ku, Sagami-hara-shi | Kanagawa 252-0143 | Japan | 81.(0)42.775.3011 Tel | [info@everpure.co.jp](mailto:info@everpure.co.jp)

**Southeast Asia** | 390 Havelock Road, | #04-01 King's Centre | Singapore 169662 | 65.6768.5800 Tel | [cseverpure@pentair.com](mailto:cseverpure@pentair.com)

All indicated Pentair trademarks and logos are property of Pentair. Third party registered and unregistered trademarks and logos are the property of their respective owners.  
Pentair is an equal opportunity employer.

©2022 Pentair. All Rights Reserved.

EV3159-32 Rev A AP22