

EZ-RO™ 200/16G-BL BLENDED REVERSE OSMOSIS SYSTEM

System Part Number: EV9975-62



EZ-RO 200/16G-BL wall mount



EZ-RO 200/16G-BL with optional floor stand bracket



16-gallon hydropneumatic tank

SYSTEM DESCRIPTION

Leveraging proprietary technology, the **EZ-RO 200/16G-BL** system uses Reverse Osmosis (RO) to reduce Total Dissolved Solids (TDS); it provides up to 200 gal/day (757 L/day)* and includes a 16-gallon (60.6 L) hydropneumatic tank. Blending and remineralization allow you to control TDS for optimal espresso, coffee and tea*.

APPLICATIONS

- ◆ Espresso
- ◆ Coffee
- ◆ Tea / iced tea
- ◆ Ice

FEATURES • BENEFITS

- ◆ Meets espresso, coffee, and tea equipment and customer water quality standards; known to significantly reduce scale and corrosion problems due to high TDS, water hardness*, and chlorides†
- ◆ Precision stainless steel blend valve and built-in TDS meter allow customized TDS for optimum extraction and taste profile for espresso, coffee and tea*
- ◆ 4CM cartridge provides calcium and magnesium for improved extraction
- ◆ Non-electric design operates on available water pressure‡
- ◆ Sealed hydropneumatic storage tank provides capacity and pressurized water to downstream equipment
- ◆ Pressure gauge allows monitoring of RO inlet pressure and prefilter condition
- ◆ Built-in bypass, sample port and flush valves speed up installation and cartridge replacement
- ◆ Proprietary Fibredyne™ II filtration media effectively inhibits growth of bacteria on the filter media that can decrease product life. Also can reduce sediment and chlorine to help protect the RO membrane*
- ◆ High flow 1/2" OD tubing optimized water line to equipment
- ◆ Installation kit comes complete with tubing, fittings, and mounting hardware for installation
- ◆ High efficiency RO membrane saves up to two times more water than standard RO membranes‡
- ◆ Numerous patents pending on blending technology and other aspects of the product design

INSTALLATION TIPS

- ◆ Feed water connection to system—should be COLD only. Tempered water up to 80°F (26.6°C) can be used.
- ◆ Do not exceed system specifications for temperature and pressure.
- ◆ Provide a dedicated feed water supply connection of at least 3/8" inner diameter.
- ◆ Allow 3" clearance below system for filter cartridge removal and replacement.
- ◆ Detailed, illustrated installation guide is included with each system.

*Not performance tested or certified by NSF.

† When installed, serviced and maintained according to Pentair Everpure Installation Operation Instructions.

‡ Up to 50% recovery compared to standard RO systems with 25% recovery.

EPA Est. 002623-IL-003

EZ-RO™ 200/16G-BL BLENDED REVERSE OSMOSIS SYSTEM

EV9975-62

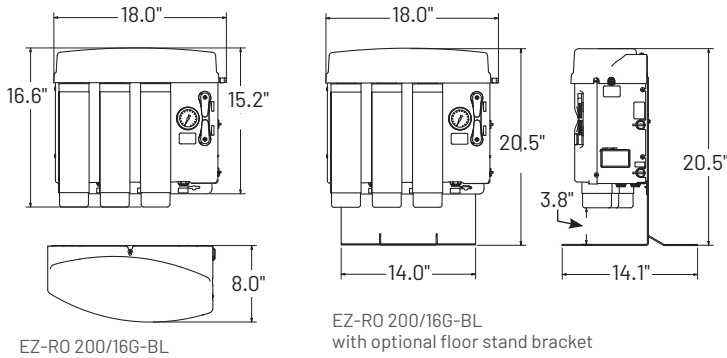

EZ-RO 200/16G-BL

EZ-RO 200/16G-BL with optional floor stand bracket

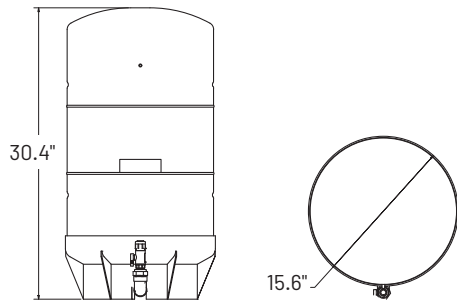

16-gallon hydropneumatic tank



System is Tested and Certified by NSF International against NSF/ANSI 58 and CSA B483.1 for the reduction of Total Dissolved Solids (TDS).

Feed Water Chemistry

Feed TDS	Up to 1000 ppm	Turbidity	<1.0 NTU
Feed pH	5-10	Manganese	<0.05 mg/L max
Hardness [†]	12 grains/gal or less	Hydrogen Sulfide	0.00 mg/L
Free Chlorine	<3 mg/L	Silica	<20 ppm
Iron	<0.1 mg/L		

[†] For water outside of these parameters, call Pentair Customer Service.

SPECIFICATIONS

System

Overall Dimensions - Processor
16.6" H x 18.0" W x 8.0" D
(42.2 cm x 45.7 cm x 20.3 cm)

Tank Dimensions & Capacity

30.4" H x 15.6" DIA
(77.2 cm x 39.6 cm)
16 gallons (60.6 L)

Connections

Inlet: 3/8" push-to-connect
Outlet: 1/2" OD push-to-connect

Pressure Requirements

50 - 100 psi
(3.5 - 6.9 bar), non-shock

Water Temperature

40-100°F (4 - 38°C)

System

Shipping Weight
57.5 lbs (26.1 kgs)

Electrical Connection
None required

Performance

Daily Production Rate

Up to 200 gpd (757 Lpd)* nominal at 77°F (25°C), 60 psi (4.1 bar) feed water pressure*; production will vary based on water supply temperature and pressure

Service Flow Rate

Dependent on water level and pressure in storage tank.

*Not performance tested or certified by NSF.

OPTIONS

Model	Description	Part No
PRV	Pressure reducing valve	164-89938
Air Gap Kit	Air gap approved for drain	164-89905
EZFS	Floor stand bracket	EV3159-68
Mixing Valve	Thermostatic mixing valve	EV3114-79

REPLACEMENT CARTRIDGES

Model	Qty	Description	Part No
4FC5-S	1	Prefilter	EV9693-31
EZ-200	1	RO membrane	EV9628-92
4CM	1	Mineral addition	EV9627-80

It is recommended that pre-/post-filters and mineral addition cartridges are changed every six (6) months, when capacity is reached, or when feed water pressure or flow becomes inadequate.

The contaminants or other substances removed or reduced by this drinking water system are not necessarily in your water. Do not use with water that is microbiologically unsafe or of unknown quality without adequate disinfection before or after the system.

Since the conditions under which our products may be used are beyond our control, we cannot accept any liability with respect to the improper installation, application and/or use of our products.



For Pentair Everpure Product Warranties visit:
<http://pentair.com/assets/foodservice-warranty>

For Pentair Patent Information visit:
<http://pentair.com/patents>

United States | 1040 Muirfield Drive | Hanover Park, IL 60133 | 800.942.1153 (US Only) 630.307.3000 Main | cseverpure@pentair.com | foodservice.pentair.com
Australia | 1-21 Monash Drive | Dandenong South, Vic 3175 | Australia | 011.1300 576 190 Tel | au.everpure@pentair.com
China | 21F Cloud 9 Plaza, NO 1118 | Shanghai, 200052 | China | 86.21.3211.4588 Tel | china.water@pentair.com
India | Boulevard, B-9/A, 7th Floor - Tower B Sector 62 | Noida - 201301 | 91.120.419.9444 Tel | indiacustomer@pentair.com
Europe | Pentair Water Belgium BV | Industriepark Wolfstee, Toekomstlaan 30, B-2200 Herentals | Belgium | +32.(0).14.283.504 Tel | sales@everpure-europe.com
Japan | Japan Inc. | Hashimoto MN Bldg. 7F, | 3-25-1 Hashimoto, Midori-ku, Sagami-hara-shi | Kanagawa 252-0143 | Japan | 81.(0)4.2775.3011 Tel | info@everpure.co.jp
Southeast Asia | 390 Havelock Road, | #04-01 King's Centre | Singapore 169662 | 65.6768.5800 Tel | cseverpure@pentair.com

All indicated Pentair trademarks and logos are property of Pentair. Third party registered and unregistered trademarks and logos are the property of their respective owners.